

Product overview

Batteries for Trucks, Buses, Construction, Agriculture

StartPRO DG1101



Part number	DG1101
Technology	Flooded
EAN/GTIN	3661024025386
Voltage	12 V
Capacity	110 Ah
CCA	750 A
Length	349 mm
Width	175 mm
Height	235 mm
Box size	D02
Polarity	ETN 1
Terminal Type	EN taper post
Hold Down	B0
Weights (subject of variation)	25.40 kg

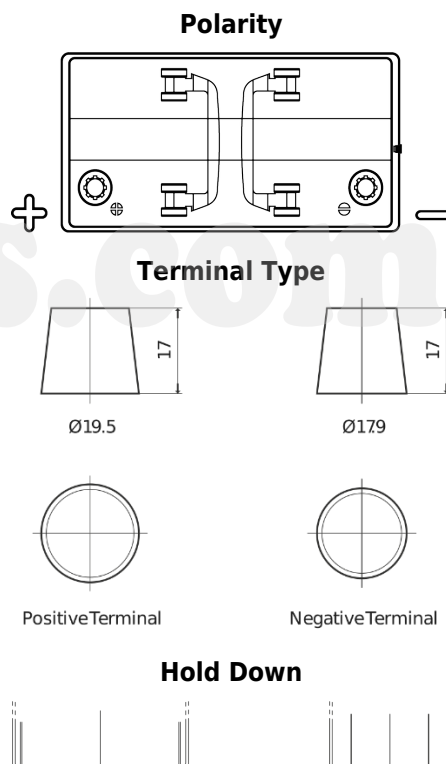

Design, features and specifications are subject to change without notice. We disclaim any representation or warranty, express or implied, concerning the data or recommendations, and in no event shall be liable for any loss or damage claimed to have arisen as a result. Some products may not be available in your local market.