

# FT185



## CYCLING CAPACITY

20 Hour Rate     **14 Amp Hours**

## RESERVE CAPACITY

Reserve @25 AMPS     **15 Minutes**     Reserve @75 AMPS     **3.6 Minutes**

## ELECTRICAL SPECIFICATIONS

Nominal Voltage	<b>12 Volt</b>
C100	<b>15 AH</b>
C20	<b>14 AH</b>
C5	<b>12 AH</b>
Short Circuit Current	<b>600 Amps</b>
CCA	<b>185 Amps</b>
CA or MCA	<b>240 Amps</b>
PHCA	<b>545 Amps</b>
Internal Resistance	<b>11.0 mΩ</b>

## MECHANICAL SPECIFICATIONS

Group Size	<b>BS16L-B</b>	
Terminal Type	<b>M6</b>	
Terminal Torque	<b>See reverse side</b>	
Height (w/ terminal)	<b>5.15"</b>	<b>131 mm</b>
Height (case only)	<b>5.15"</b>	<b>131 mm</b>
Width	<b>3.39"</b>	<b>86 mm</b>
Length	<b>6.97"</b>	<b>177 mm</b>
Weight	<b>11.0 lbs</b>	<b>5.0 kg</b>
Case Type	<b>ABS Plastic - Flame Res. Rating UL94-HB</b>	

## DISCHARGE TABLE (Constant Current)

Time	Amps	Rate
20hr	0.75	0.05 CA
10hr	1.40	0.10 CA
8hr	1.56	0.13 CA
5hr	2.30	0.20 CA
3hr	3.40	0.33 CA
2hr	4.00	0.50 CA
1hr	8.70	1.00 CA

## DISCHARGE PROFILE (Constant Current)

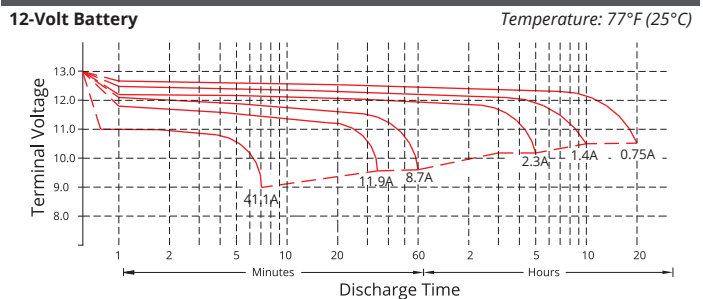

- All listed ratings are @ 100% SoC, T=77°F (25°C), 1.75VPC unless otherwise specified.
- Specifications listed are for estimation purposes only. Battery performance can vary depending on application. Battery design subject to change.

## BATTERY & TERMINAL DIMENSIONS (All units shown in mm)

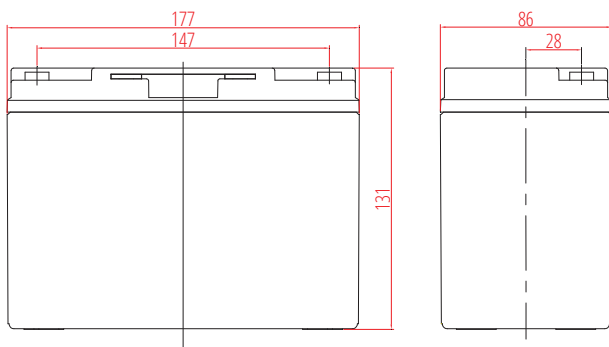

### Terminal: M6

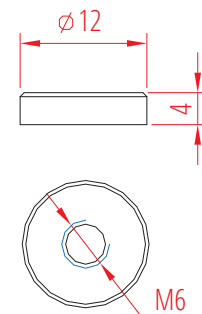

FULL THROTTLE SERIES | HIGH CRANKING AGM

fullriverbattery.com

### TEMPERATURE vs CAPACITY

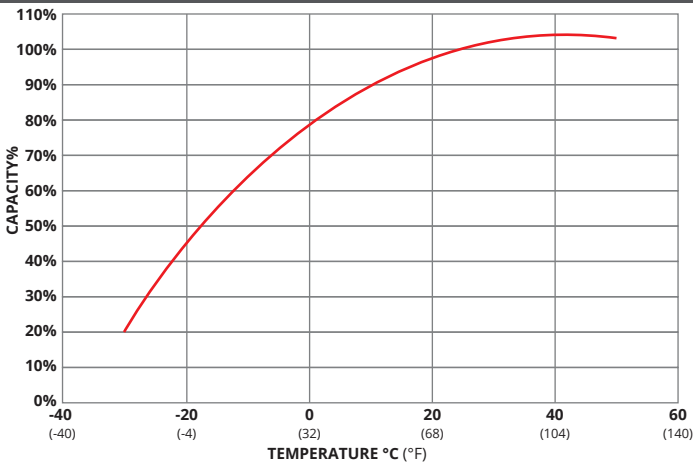

### STATE of CHARGE (SOC) vs OPEN CIRCUIT VOLTAGE (OCV)

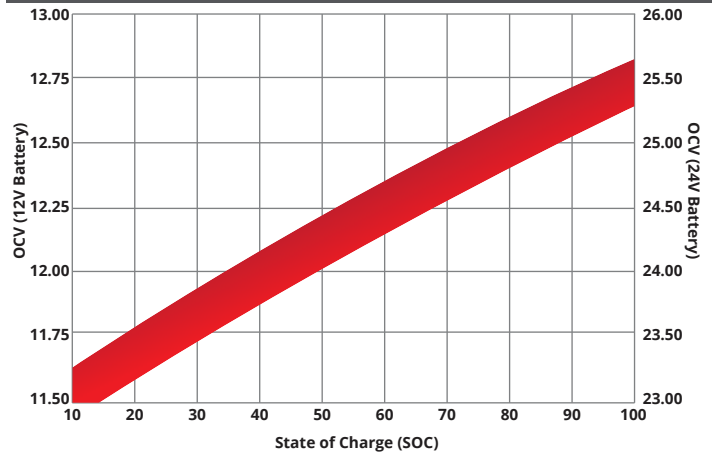

### CYCLE LIFE vs DEPTH of DISCHARGE (DOD) \*(Based on BCI Testing @ 2-hr Rate)

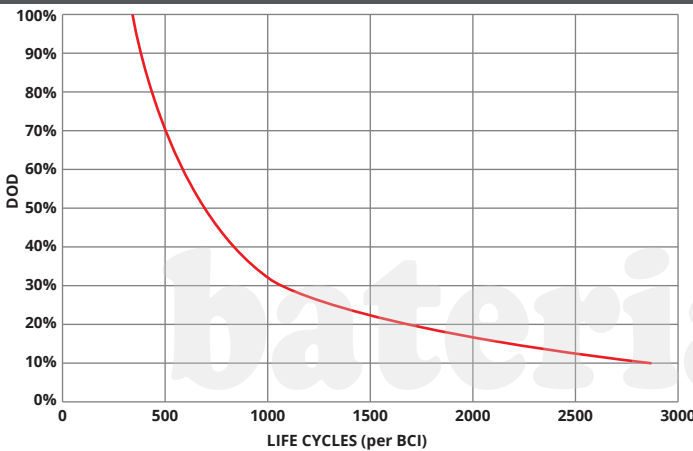

### SELF DISCHARGE vs TIME/TEMPERATURE

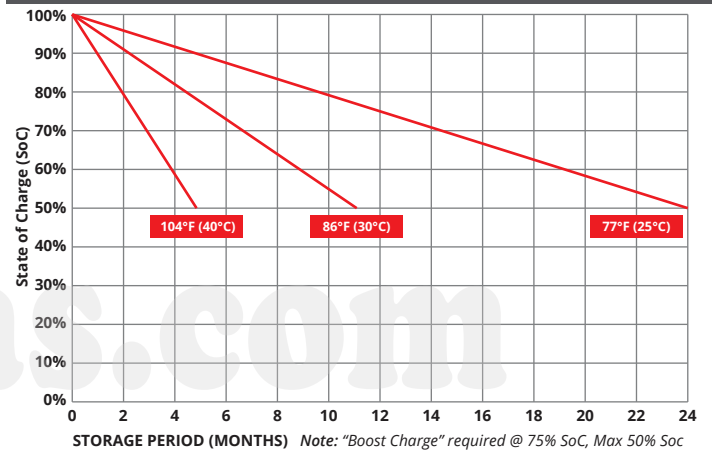

### TEMPERATURE RANGE SPECIFICATIONS

Condition	Recommended	Maximum	Recommended	Maximum
Storage	5°F to 122°F	-40°F to 160°F	-15°C to 50°C	-40°C to 71°C
Operation	5°F to 104°F	-40°F to 160°F	-15°C to 40°C	-40°C to 71°C
Charge with TC	5°F to 122°F	-40°F to 160°F	-15°C to 50°C	-40°C to 71°C
Charge w/o TC	32°F to 104°F	5°F to 122°F	0°C to 40°C	-15°C to 50°C

\*TC= Temperature Compensation

### CHARGE VOLTAGES

Charge Stage	Battery Voltages			
	12V	24V	36V	48V
Bulk	14.4 - 14.7V	28.8 - 29.4V	43.2 - 44.1V	57.6 - 58.8V
Absorption	14.4 - 14.7V	28.8 - 29.4V	43.2 - 44.1V	57.6 - 58.8V
Float	13.6V	27.2V	40.8V	54.6V

TC Factor: (-2mV°F/cell) or (-4mV°C/cell)

### TERMINAL TORQUE SPECS (applicable values are highlighted)

M6	M8	M10	M6M (Stud)	M8M (Stud)	M10M (Stud) & 3/8" Stud	FR45	TP06 (AP)	TP08/TP68 (AP)	AP
3.3-4.8ft-lbs	5.2-6.7ft-lbs	8.1-10.3ft-lbs	2.6-3.7ft-lbs	4.4-5.9ft-lbs	7.4-8.8ft-lbs	4.8-6.3ft-lbs	2.6-3.3ft-lbs	4.6-6.3ft-lbs	4.2-5.8ft-lbs
40-57.5lbs-in	62-80lbs-in	97-124lbs-in	31-44lbs-in	53-71lbs-in	88.5-106lbs-in	57-75lbs-in	31-40lbs-in	55-75lbs-in	50-70lbs-in
4.5-6.5Nm	7-9Nm	11-14Nm	3.5-5Nm	6-8Nm	10-12Nm	6.5-8.5Nm	3.5-4.5Nm	6.2-8.5Nm	5.6-7.9Nm



9001:2008 Quality Management System  
 14001:2004 Environmental Management System  
 18001:2007 Occupational Health & Safety Management System



DELIVERY APPROVED!  
**LAND, SEA & AIR**

Fullriver batteries are sealed lead acid batteries made with Absorbed Glass Mat (AGM) technology. The electrolyte is absorbed into the fiberglass separator material rather than in a free-flowing liquid form. Fullriver batteries are non-spillable electric storage batteries. They are exempted from the requirements of DOT's hazardous materials regulations, since they adhere to the requirements of code 49 CFR Section 173.159(D) - (CLASSIFIED APPROVED: DOT, CFR, HMR49, IATA, ICAO67, IMDG27)