

FT965-27F



CYCLING CAPACITY

20 Hour Rate **100 Amp Hours**

RESERVE CAPACITY

Reserve @25 AMPS **185 Minutes** Reserve @75 AMPS **40 Minutes**

ELECTRICAL SPECIFICATIONS

| | |
|-----------------------|------------------|
| Nominal Voltage | 12 Volt |
| C100 | 110 AH |
| C20 | 100 AH |
| C5 | 81 AH |
| Short Circuit Current | 5000 Amps |
| CCA | 965 Amps |
| CA or MCA | 1170 Amps |
| PHCA | 1950 Amps |
| Internal Resistance | 2.5 mΩ |

MECHANICAL SPECIFICATIONS

| | | |
|----------------------|--|----------------|
| Group Size | 27F | |
| Terminal Type | DT | |
| Terminal Torque | See reverse side | |
| Height (w/ terminal) | 9.33" | 237 mm |
| Height (case only) | 8.43" | 214 mm |
| Width | 6.65" | 169 mm |
| Length | 12.09" | 307 mm |
| Weight | 69.5 lbs | 31.5 kg |
| Case Type | ABS Plastic - Flame Res. Rating UL94-HB | |

DISCHARGE TABLE (Constant Current)

| Time | Amps | Rate |
|------|------|---------|
| 20hr | 5.0 | 0.05 CA |
| 10hr | 9.1 | 0.10 CA |
| 8hr | 10.9 | 0.13 CA |
| 5hr | 17.2 | 0.20 CA |
| 3hr | 25.1 | 0.33 CA |
| 2hr | 34.0 | 0.50 CA |
| 1hr | 60.0 | 1.00 CA |

DISCHARGE PROFILE (Constant Current)

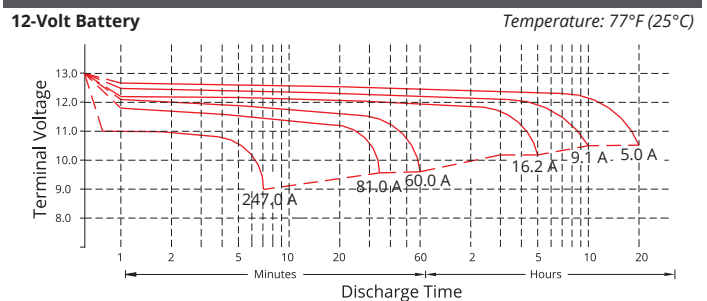

- All listed ratings are @ 100% SoC, T=77°F (25°C), 1.75VPC unless otherwise specified.
- Specifications listed are for estimation purposes only. Battery performance can vary depending on application. Battery design subject to change.

BATTERY & TERMINAL DIMENSIONS (All units shown in mm)

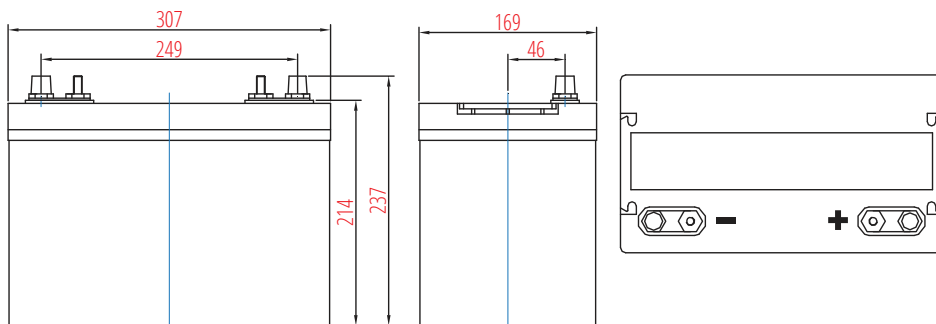

Terminal: DT

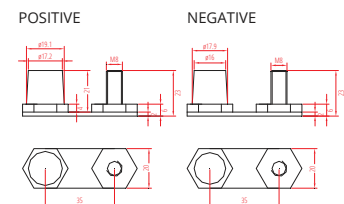

TEMPERATURE vs CAPACITY

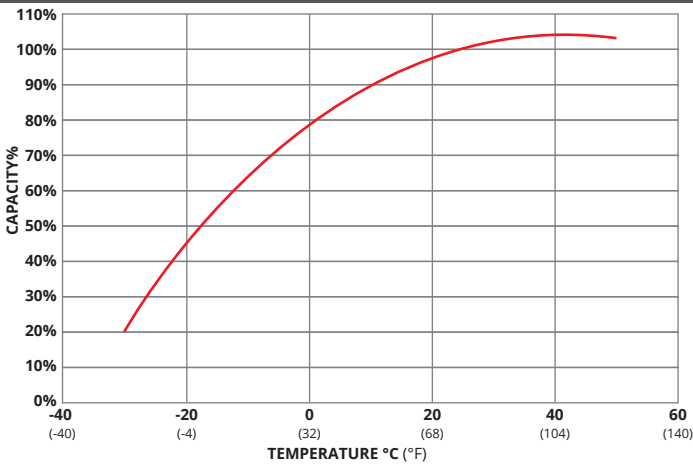

STATE of CHARGE (SOC) vs OPEN CIRCUIT VOLTAGE (OCV)

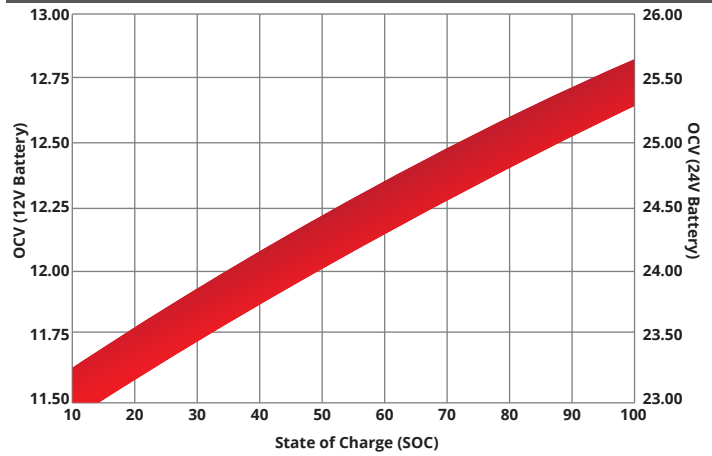

CYCLE LIFE vs DEPTH of DISCHARGE (DOD) *(Based on BCI Testing @ 2-hr Rate)

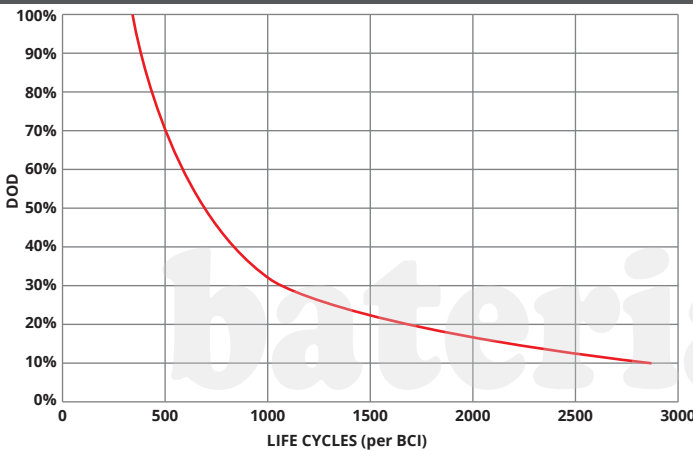

SELF DISCHARGE vs TIME/TEMPERATURE

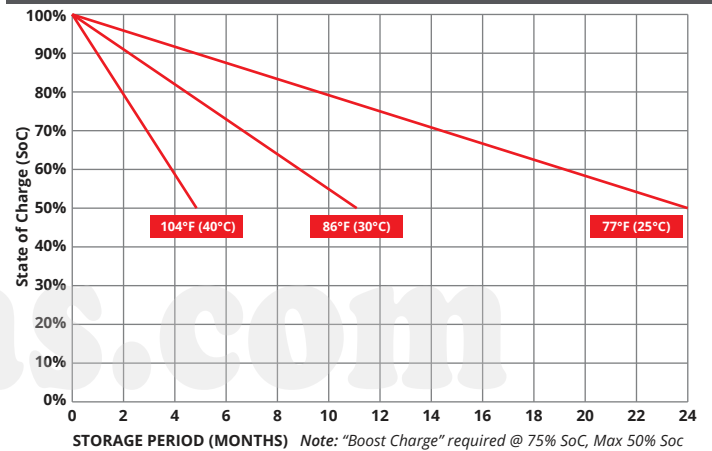

TEMPERATURE RANGE SPECIFICATIONS

| Condition | Recommended | Maximum | Recommended | Maximum |
|----------------|---------------|----------------|---------------|---------------|
| Storage | 5°F to 122°F | -40°F to 160°F | -15°C to 50°C | -40°C to 71°C |
| Operation | 5°F to 104°F | -40°F to 160°F | -15°C to 40°C | -40°C to 71°C |
| Charge with TC | 5°F to 122°F | -40°F to 160°F | -15°C to 50°C | -40°C to 71°C |
| Charge w/o TC | 32°F to 104°F | 5°F to 122°F | 0°C to 40°C | -15°C to 50°C |

*TC= Temperature Compensation

CHARGE VOLTAGES

| Charge Stage | Battery Voltages | | | |
|--------------|------------------|--------------|--------------|--------------|
| | 12V | 24V | 36V | 48V |
| Bulk | 14.4 - 14.7V | 28.8 - 29.4V | 43.2 - 44.1V | 57.6 - 58.8V |
| Absorption | 14.4 - 14.7V | 28.8 - 29.4V | 43.2 - 44.1V | 57.6 - 58.8V |
| Float | 13.6V | 27.2V | 40.8V | 54.6V |

TC Factor: (-2mV°F/cell) or (-4mV°C/cell)

TERMINAL TORQUE SPECS (applicable values are highlighted)

| M6 | M8 | M10 | M6M (Stud) | M8M (Stud) | M10M (Stud) & 3/8" Stud | FR45 | TP06 (AP) | TP08/TP68 (AP) | AP |
|---------------|---------------|----------------|---------------|---------------|-------------------------|---------------|---------------|----------------|---------------|
| 3.3-4.8ft-lbs | 5.2-6.7ft-lbs | 8.1-10.3ft-lbs | 2.6-3.7ft-lbs | 4.4-5.9ft-lbs | 7.4-8.8ft-lbs | 4.8-6.3ft-lbs | 2.6-3.3ft-lbs | 4.6-6.3ft-lbs | 4.2-5.8ft-lbs |
| 40-57.5lbs-in | 62-80lbs-in | 97-124lbs-in | 31-44lbs-in | 53-71lbs-in | 88.5-106lbs-in | 57-75lbs-in | 31-40lbs-in | 55-75lbs-in | 50-70lbs-in |
| 4.5-6.5Nm | 7-9Nm | 11-14Nm | 3.5-5Nm | 6-8Nm | 10-12Nm | 6.5-8.5Nm | 3.5-4.5Nm | 6.2-8.5Nm | 5.6-7.9Nm |



9001:2008 Quality Management System
 14001:2004 Environmental Management System
 18001:2007 Occupational Health & Safety Management System



TPPL TECHNOLOGY

DELIVERY APPROVED!
LAND, SEA & AIR

Fullriver batteries are sealed lead acid batteries made with Absorbed Glass Mat (AGM) technology. The electrolyte is absorbed into the fiberglass separator material rather than in a free-flowing liquid form. Fullriver batteries are non-spillable electric storage batteries. They are exempted from the requirements of DOT's hazardous materials regulations, since they adhere to the requirements of code 49 CFR Section 173.159(D) - (CLASSIFIED APPROVED: DOT, CFR, HMR49, IATA, ICAO67, IMDG27)