



DCG40-12



CYCLING CAPACITY

20 Hour Rate **40 Amp Hours**

RESERVE CAPACITY

Reserve @25 AMPS **51 Minutes** Reserve @75 AMPS **11 Minutes**

ELECTRICAL SPECIFICATIONS

| | |
|---------------------|-----------------|
| Nominal Voltage | 12 Volt |
| C100 | 46 AH |
| C20 | 40 AH |
| C10 | 36 AH |
| C5 | 33 AH |
| CCA | 235 Amps |
| CA or MCA | 300 Amps |
| PHCA | - |
| Internal Resistance | 11.0mΩ |

MECHANICAL SPECIFICATIONS

| | | |
|----------------------|--|----------------|
| Group Size | U1L | |
| Terminal Type | M6 | |
| Terminal Torque | See reverse side | |
| Height (w/ terminal) | 6.73" | 171mm |
| Height (case only) | 6.73" | 171mm |
| Width | 6.54" | 166mm |
| Length | 7.80" | 198mm |
| Weight | 29.76 lbs. | 13.5 kg |
| Case Type | ABS Plastic - Flame Res. Rating UL94-HB | |

DISCHARGE TABLE (Constant Current)

| Time | Amps | Rate |
|------|------|--------|
| 20hr | 2.0 | 0.05CA |
| 10hr | 3.7 | 0.10CA |
| 8hr | 4.4 | 0.13CA |
| 5hr | 6.7 | 0.25CA |
| 3hr | 9.8 | 0.33CA |
| 2hr | 13.4 | 0.50CA |
| 1hr | 23.4 | 1.00CA |

DISCHARGE PROFILE (Constant Current)

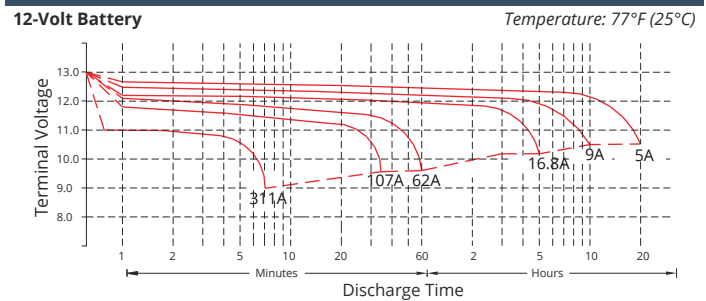

- All listed ratings are @ 100% SoC, T=77°F (25°C), 1.75VPC unless otherwise specified.
 - Specifications listed are for estimation purposes only. Battery performance can vary depending on application. Battery design subject to change.

BATTERY & TERMINAL DIMENSIONS (All units shown in mm)

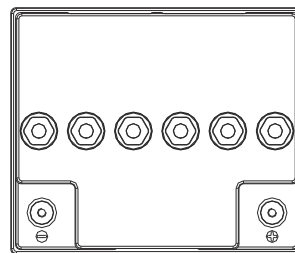
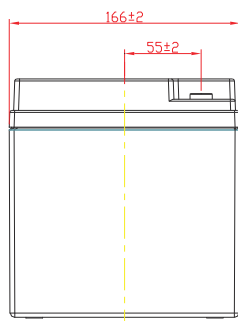
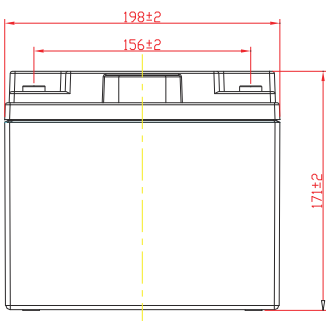

Terminal: M6

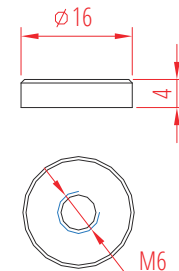

PREMIUM DEEP CYCLE GEL SERIES | DEEP CYCLE GEL

fullriverbattery.com

TEMPERATURE vs CAPACITY

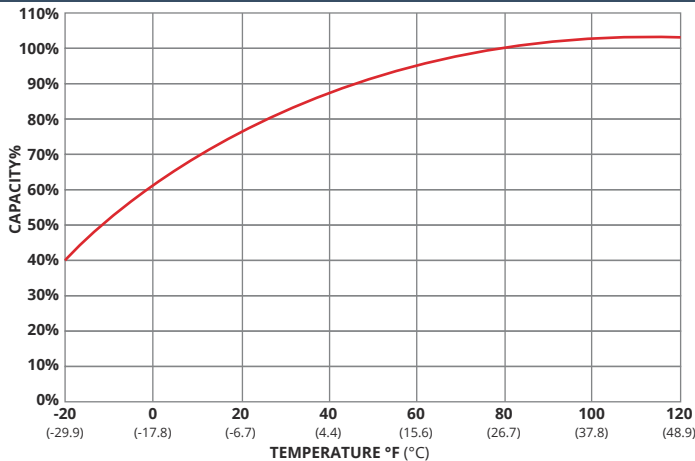

STATE of CHARGE (SOC) vs OPEN CIRCUIT VOLTAGE (OCV)

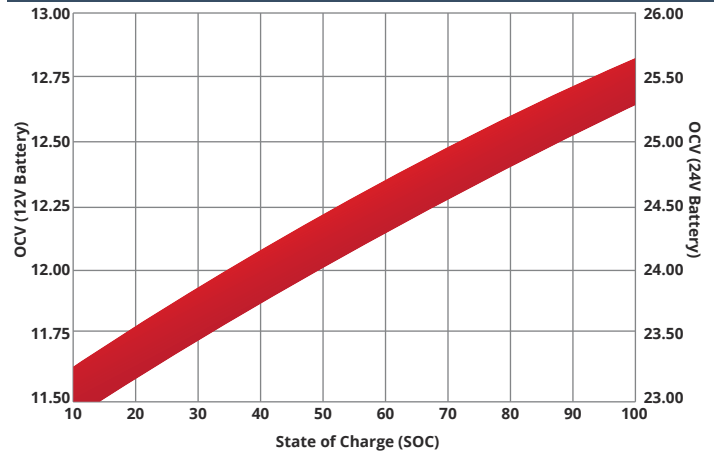

CYCLE LIFE vs DEPTH of DISCHARGE (DOD)

*(Based on BCI Testing @ 2-hr Rate)

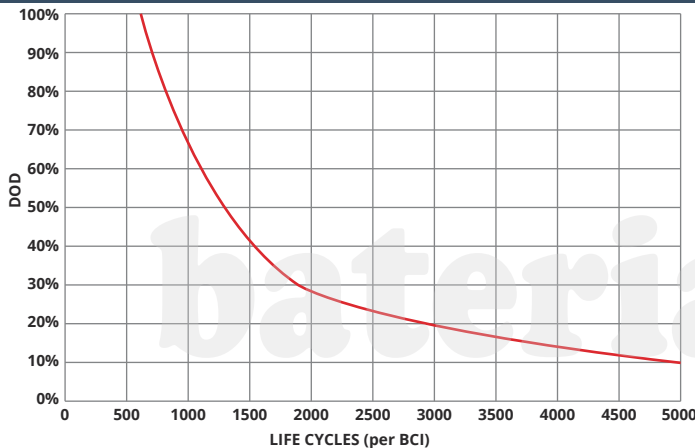

SELF DISCHARGE vs TIME/TEMPERATURE

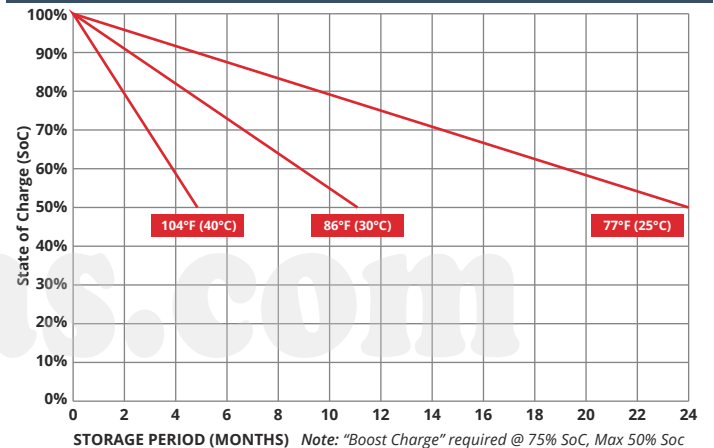

TEMPERATURE RANGE SPECIFICATIONS

| Condition | Recommended | Maximum | Recommended | Maximum |
|----------------|---------------|----------------|---------------|---------------|
| Storage | 5°F to 122°F | -40°F to 160°F | -15°C to 50°C | -40°C to 71°C |
| Operation | 5°F to 104°F | -40°F to 160°F | -15°C to 40°C | -40°C to 71°C |
| Charge with TC | 5°F to 122°F | -40°F to 160°F | -15°C to 50°C | -40°C to 71°C |
| Charge w/o TC | 32°F to 104°F | 5°F to 122°F | 0°C to 40°C | -15°C to 50°C |

*TC= Temperature Compensation

CHARGE VOLTAGES

| Charge Stage | Battery Voltages | | | |
|--------------|------------------|-------|-------|-------|
| | 12V | 24V | 36V | 48V |
| Bulk | 14.7V | 29.4V | 44.1V | 58.8V |
| Absorption | 14.7V | 29.4V | 44.1V | 58.8V |
| Float | 13.6V | 27.2V | 40.8V | 54.6V |

TC Factor: (-2mV/°F/cell) or (-4mV/°C/cell)

TERMINAL TORQUE SPECS (applicable values are highlighted)

| M6, AP | M8 | M10 | M6M (Stud) | M8M (Stud) | M10M (Stud) | 3/8" Stud | FR45 | TP06 (AP) | TP08/TP68 (AP) |
|---------------|---------------|---------------|---------------|---------------|---------------|---------------|---------------|---------------|----------------|
| 4.1-5.8ft-lbs | 7.1-7.9ft-lbs | 9.6-12ft-lbs | 3.3-4.6ft-lbs | 4.9-6.3ft-lbs | 7.7-9.6ft-lbs | 8.9-12ft-lbs | 5.8-7.4ft-lbs | 3.3-4.6ft-lbs | 50-70ft-lbs |
| 50-70lbs-in | 85-95lbs-in | 115-141lbs-in | 40-56lbs-in | 58-75lbs-in | 92-115lbs-in | 106-150lbs-in | 70-90lbs-in | 40-56lbs-in | 63-83lbs-in |
| 5.6-7.9Nm | 9.6-10.7Nm | 13-16Nm | 4.5-6.3Nm | 6.6-8.5Nm | 10.4-13Nm | 12-16.9Nm | 7.9-10.1Nm | 4.5-6.3Nm | 7.1-9.4Nm |



9001:2008 Quality Management System
 14001:2004 Environmental Management System
 18001:2007 Occupational Health & Safety Management System



DELIVERY APPROVED!
**LAND, SEA
 & AIR**

Fullriver batteries are sealed lead acid batteries made with Absorbed Glass Mat (AGM) technology. The electrolyte is absorbed into the fiberglass separator material rather than in a free-flowing liquid form. Fullriver batteries are non-spillable electric storage batteries. They are excepted from the requirements of DOT's hazardous materials regulations, since they adhere to the requirements of code 49 CFR Section 173.159(D) - (CLASSIFIED APPROVED: DOT, CFR, HMR49, IATA, ICAO67, IMDG27)