



# DCG79-12



### CYCLING CAPACITY

20 Hour Rate     **79 Amp Hours**

### RESERVE CAPACITY

Reserve @25 AMPS     **130 Minutes**     Reserve @75 AMPS     **37 Minutes**

### ELECTRICAL SPECIFICATIONS

Nominal Voltage	<b>12 Volt</b>
C100	<b>87 AH</b>
C20	<b>79 AH</b>
C10	<b>71.5 AH</b>
C5	<b>70 AH</b>
CCA	<b>485 Amps</b>
CA or MCA	<b>595 Amps</b>
HPCA	-
Internal Resistance	<b>9.5mΩ</b>

### MECHANICAL SPECIFICATIONS

Group Size	<b>30H</b>	
Terminal Type	<b>AP</b>	
Terminal Torque	<b>See reverse side</b>	
Height (w/ terminal)	<b>9.13"</b>	<b>232mm</b>
Height (case only)	<b>8.35"</b>	<b>212mm</b>
Width	<b>6.65"</b>	<b>169mm</b>
Length	<b>12.91"</b>	<b>328mm</b>
Weight	<b>64.15 lbs.</b>	<b>29.1 kg</b>
Case Type	<b>ABS Plastic - Flame Res. Rating UL94-HB</b>	

### DISCHARGE TABLE (Constant Current)

Time	Amps	Rate
20hr	3.95	0.05CA
10hr	7.4	0.10CA
8hr	8.8	0.13CA
5hr	13.3	0.25CA
3hr	19.5	0.33CA
2hr	26.5	0.50CA
1hr	46.2	1.00CA

### DISCHARGE PROFILE (Constant Current)

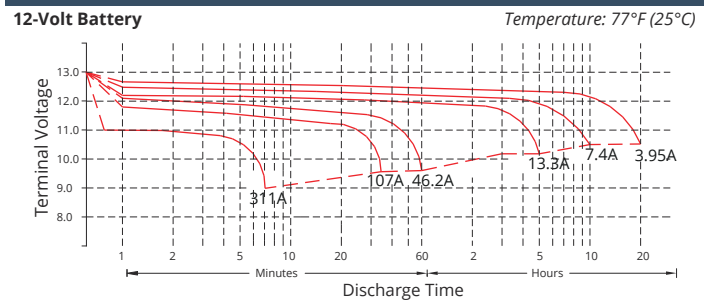

- All listed ratings are @ 100% SoC, T=77°F (25°C), 1.75VPC unless otherwise specified.  
 - Specifications listed are for estimation purposes only. Battery performance can vary depending on application. Battery design subject to change.

### BATTERY & TERMINAL DIMENSIONS (All units shown in mm)

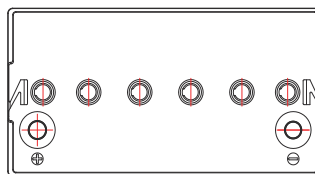
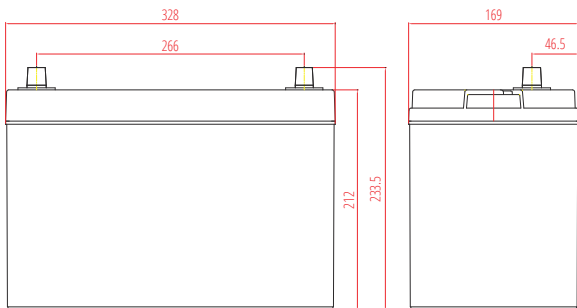

### Terminal: AP

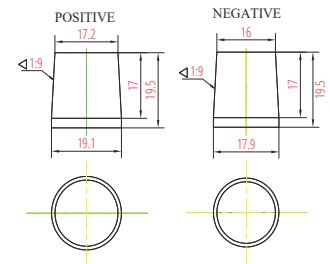

PREMIUM DEEP CYCLE GEL SERIES | DEEP CYCLE GEL

fullriverbattery.com

## TEMPERATURE vs CAPACITY

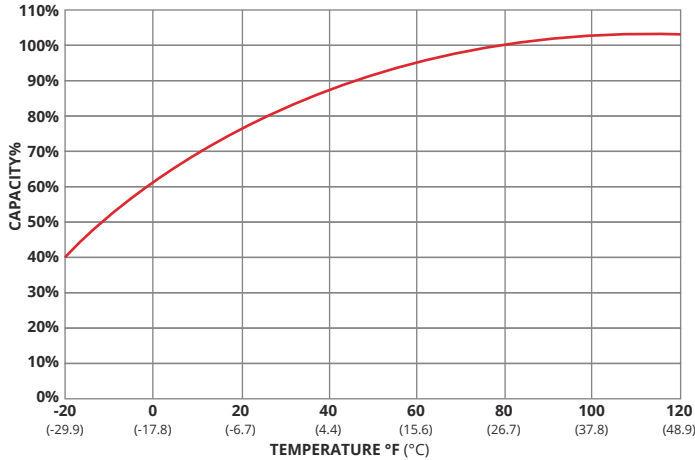

## STATE of CHARGE (SOC) vs OPEN CIRCUIT VOLTAGE (OCV)

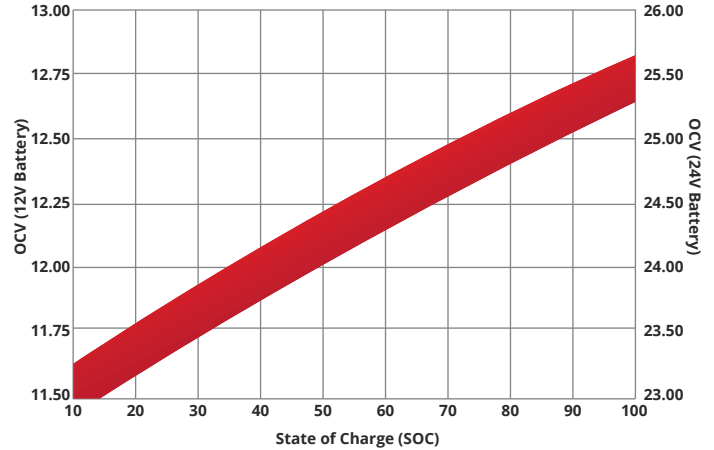

## CYCLE LIFE vs DEPTH of DISCHARGE (DOD)

\*(Based on BCI Testing @ 2-hr Rate)

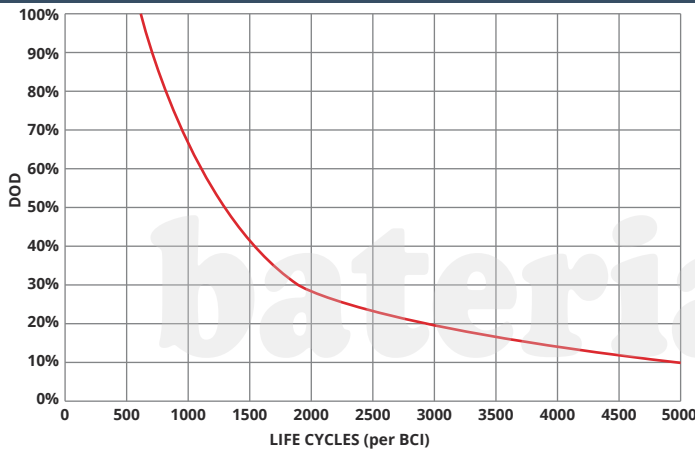

## SELF DISCHARGE vs TIME/TEMPERATURE

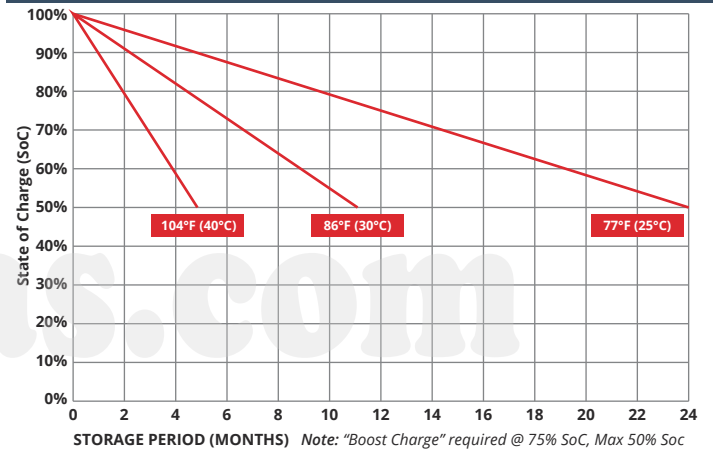

## TEMPERATURE RANGE SPECIFICATIONS

Condition	Recommended	Maximum	Recommended	Maximum
Storage	5°F to 122°F	-40°F to 160°F	-15°C to 50°C	-40°C to 71°C
Operation	5°F to 104°F	-40°F to 160°F	-15°C to 40°C	-40°C to 71°C
Charge with TC	5°F to 122°F	-40°F to 160°F	-15°C to 50°C	-40°C to 71°C
Charge w/o TC	32°F to 104°F	5°F to 122°F	0°C to 40°C	-15°C to 50°C

\*TC= Temperature Compensation

## CHARGE VOLTAGES

Charge Stage	Battery Voltages			
	12V	24V	36V	48V
Bulk	14.7V	29.4V	44.1V	58.8V
Absorption	14.7V	29.4V	44.1V	58.8V
Float	13.6V	27.2V	40.8V	54.6V

TC Factor: (-2mV/°F/cell) or (-4mV/°C/cell)

## TERMINAL TORQUE SPECS (applicable values are highlighted)

M6, AP	M8	M10	M6M (Stud)	M8M (Stud)	M10M (Stud)	3/8" Stud	FR45	TP06 (AP)	TP08/TP68 (AP)
4.1-5.8ft-lbs	7.1-7.9ft-lbs	9.6-12ft-lbs	3.3-4.6ft-lbs	4.9-6.3ft-lbs	7.7-9.6ft-lbs	8.9-12ft-lbs	5.8-7.4ft-lbs	3.3-4.6ft-lbs	50-70ft-lbs
50-70lbs-in	85-95lbs-in	115-141lbs-in	40-56lbs-in	58-75lbs-in	92-115lbs-in	106-150lbs-in	70-90lbs-in	40-56lbs-in	63-83lbs-in
5.6-7.9Nm	9.6-10.7Nm	13-16Nm	4.5-6.3Nm	6.6-8.5Nm	10.4-13Nm	12-16.9Nm	7.9-10.1Nm	4.5-6.3Nm	7.1-9.4Nm



9001:2008 Quality Management System  
 14001:2004 Environmental Management System  
 18001:2007 Occupational Health & Safety Management System



DELIVERY APPROVED!  
**LAND, SEA  
 & AIR**

Fullriver batteries are sealed lead acid batteries made with Absorbed Glass Mat (AGM) technology. The electrolyte is absorbed into the fiberglass separator material rather than in a free-flowing liquid form. Fullriver batteries are non-spillable electric storage batteries. They are excepted from the requirements of DOT's hazardous materials regulations, since they adhere to the requirements of code 49 CFR Section 173.159(D) - (CLASSIFIED APPROVED: DOT, CFR, HMR49, IATA, ICAO67, IMDG27)