

⚡ Specifications

Nominal Voltage(V)

12V

Nominal Capacity

20 hour rate	(2.5A to 10.50V)	50Ah
10 hour rate	(4.75A to 10.50V)	47.5Ah
5 hour rate	(8.5A to 10.20V)	42.5Ah
1 C	(50A to 9.60V)	28.33Ah
3 C	(150A to 9.60V)	20Ah

Weight

Approx. 15.1kg(33.2Lbs.)

Internal Resistance (at 1KHz)

Approx. 5 mΩ

Maximum Discharge Current for

5 seconds: 600A

Charging Methods at 25°C(77°F)

Cycle use:	
Charging Voltage	14.4 to 15.0V
Coefficient	-5.0mV/°C/cell
Maximum Charging Current :	15A
Standby use:	
Float Charging Voltage	13.5 to 13.8V
Coefficient	-3.0mV/°C/cell

Operating Temperature Range

Charge	-15°C(5°F)	to	40°C(104°F)
Discharge	-15°C(5°F)	to	50°C(122°F)
Storage	-15°C(5°F)	to	40°C(104°F)

Charge Retention (shelf life) at 20°C(68°F)

1 month	98%
3 month	94%
6 month	85%

Case Material

ABS UL94 HB
Option: Flammability resistance of (UL94 V-0)

Design Life

3-5 Years.

Terminal

F4



⚡ Dimensions

Length (L)	199+3-1 (7.83+0.12-0.04)
Width (W)	166+3-1 (6.54+0.12-0.04)
Height (H)	171+3-1 (6.73+0.12-0.04)
Overall Height (HT)	171+3-1 (6.73+0.12-0.04)

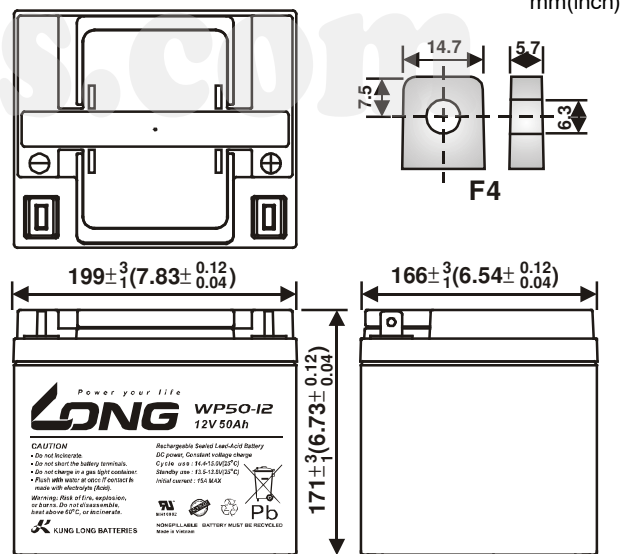

(V) FOR 12V BATTERY Discharge Time VS. Discharge Current (25°C)

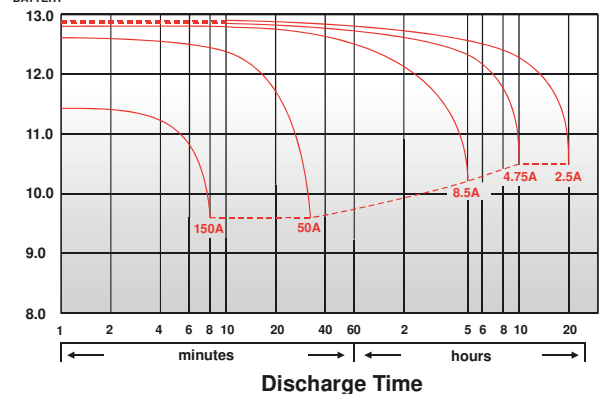

Effect of Temperature on Capacity 25°C(77°F)

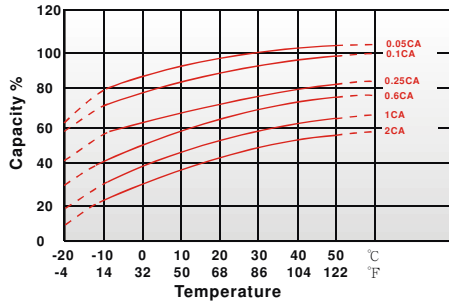

Capacity Retention Characteristic

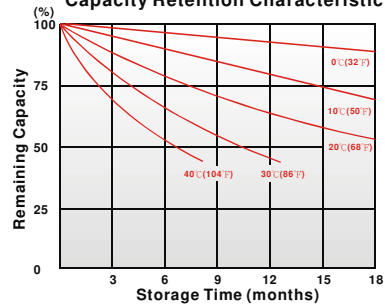

Cycle Service Life

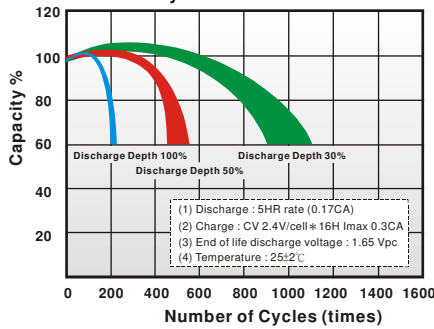

Trickle (or float) Service Life

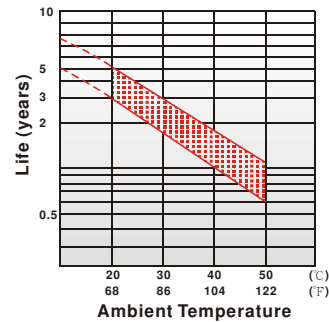

- PERFORMANCE DATA

Discharge Rates in Watts to Various End Voltages at 25°C(77°F)

End Voltage		1.85V	1.80V	1.75V	1.70V	1.67V	1.65V	1.60V
Time								
5	min	240	288	322	345	350	356	361
10	min	171	203	223	233	237	241	246
15	min	126	146	160	167	170	172	175
30	min	78.0	89.8	97.2	100	102	103	104
60	min	53.7	56.5	58.2	59.5	60.0	60.7	61.2
120	min	29.2	32.0	33.3	34.5	34.8	35.3	35.8
180	min	20.8	22.7	23.8	24.7	25.0	25.3	25.7
240	min	17.2	18.3	19.0	19.7	19.8	20.2	20.5
300	min	15.9	16.6	17.0	17.3	17.5	17.7	17.8
600	min	8.62	9.10	9.38	9.57	9.62	9.68	9.77
1200	min	4.58	4.87	5.05	5.17	5.20	5.25	5.30

- Discharge Rates in Amperes to Various End Voltages at 25°C(77°F)

End Voltage		1.85V	1.80V	1.75V	1.70V	1.67V	1.65V	1.60V
Time								
5	min	139	166	185	199	206	210	214
10	min	88.5	106	117	125	128	131	134
15	min	77.8	84.5	87.6	90.2	90.9	91.8	92.9
30	min	45.4	50.7	52.8	54.4	54.9	55.5	56.2
60	min	26.0	28.8	29.9	30.6	30.8	31.1	31.4
120	min	15.1	16.2	16.8	17.3	17.5	17.7	17.9
180	min	11.0	11.7	12.1	12.4	12.5	12.6	12.7
240	min	8.96	9.44	9.70	9.89	9.96	10.1	10.2
300	min	7.85	8.26	8.50	8.67	8.73	8.80	8.87
600	min	4.41	4.65	4.76	4.82	4.84	4.87	4.91
1200	min	2.32	2.44	2.50	2.55	2.57	2.59	2.61

All data on the spec. sheet is an average value:

The tolerance range : X<6min(+15%~-15%), 6min ≤ X < 10min(+12%~-12%), 10min ≤ X < 60min(+8%~-8%), X ≥ 60min(+5%~-5%)

160120-1J