

DC26-12A DATA SHEET



DC26-12A

26AH@20HR

12-Volt

DEEP CYCLE

Maintenance-Free
Sealed AGM Battery

Nominal Specifications			
Battery Model	DC26-12A	Rated Capacity	26AH/20HR
Mechanical Specifications			
Group Size	N/A		
Overall Height (H)	174±1.5mm	6.85"	
Container Height (h)	174±1.5mm	6.85"	
Length	166±1mm	6.54"	
Width	126±1mm	4.96"	
Weight	Approx.10.3kg	22.71lbs.	
Terminal Type	M5- Button Terminal		
Terminal Torque	2.0~3.0 N.m		
Container Material	ABS: Standard (UL 94-HB)		

Electrical Specifications	
C100	30AH
C20	26AH
C10	24.2AH
C5	22.0AH
CCA	160A
CA or MCA	195A
HPCA	230A
Max. Discharge Current	390A (5s)
Internal Resistance	8mΩ
Reserve Capacity	
Reserve @25 AMPS	30 Minutes
Reserve @75 AMPS	/

Temperature Range Specifications	
Operating Temperature Range	Discharge : -15°C ~+ 50°C (5°F ~122°F)
	Charge: -15°C ~ +40°C (5°F ~104°F)
	Storage: -15°C ~ +40°C (5°F ~104°F)
Recommended Operating Temperature Range	+74°F (23°C) to +80°F (27°C)
Self-Discharge	Less than 10% after 90 days, can be stored up to 6 months at 25°C (77°F); Fully recharging is required before usage, For higher temperatures the time interval will be shorter.

Charge Voltages		
Float Charging Voltage	13.5 to 13.8 VDC/unit@ (25°C)	
Equalization and Cycle Service Charging Voltage	14.3 to 14.5 VDC/unit @ (25°C)	
Maximum Charge Current(A)	6.5A	
Charging Temperature Compensation	Cycle use	-4mV/cell/°C
	Float use	-3mV/cell/°C

BATTERY & TERMINAL DIMENSIONS (All units shown in mm)

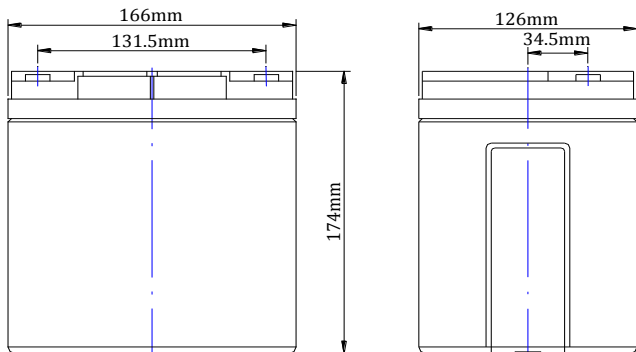

Battery bank spacing required 12.5mm (1/2"inch) minimum

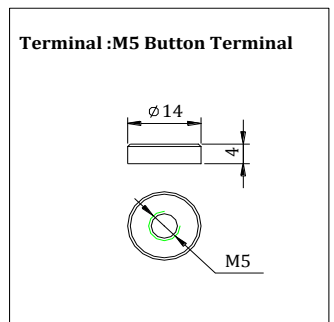
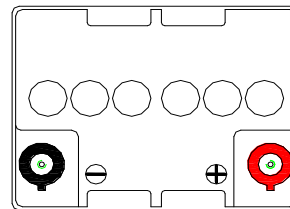

Constant Current Discharge Rating Amperes @ 77°F (25°C)

Cut off voltage V/cell	15M	30M	45M	1H	2H	3H	5H	8H	10H	12H	20H
1.75V	40	24.7	18.2	14.5	8.4	6.37	4.33	2.96	2.42	2.06	1.30

Note The above data are average values, and can be obtained with 3 charge/discharge cycles. These are not minimum values.



DC26-12A DATA SHEET

Terminal Voltage(V) and Discharge Time

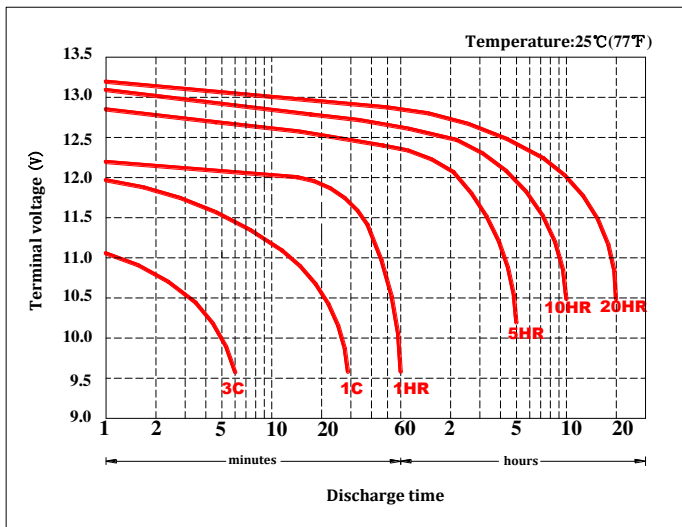

Duration of discharge vs. Discharge current

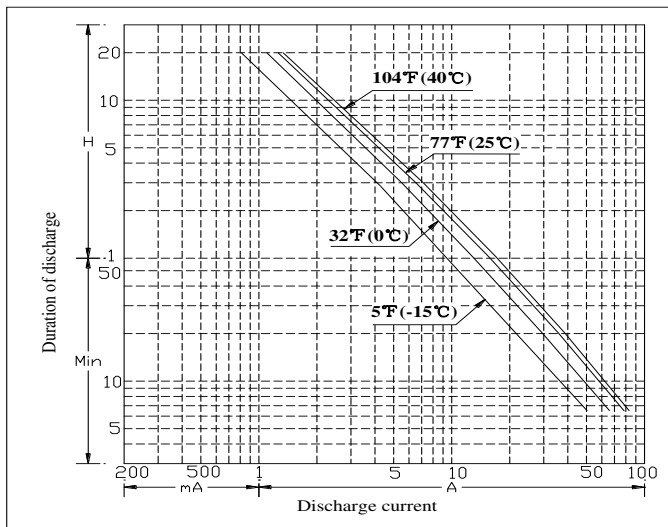

Percent Capacity vs. Temperature

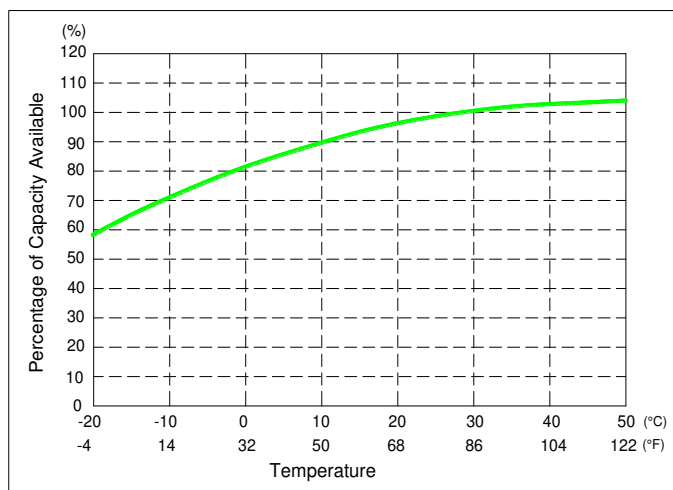

State of Charge(SOC) vs Open Circuit Voltage(OCV)

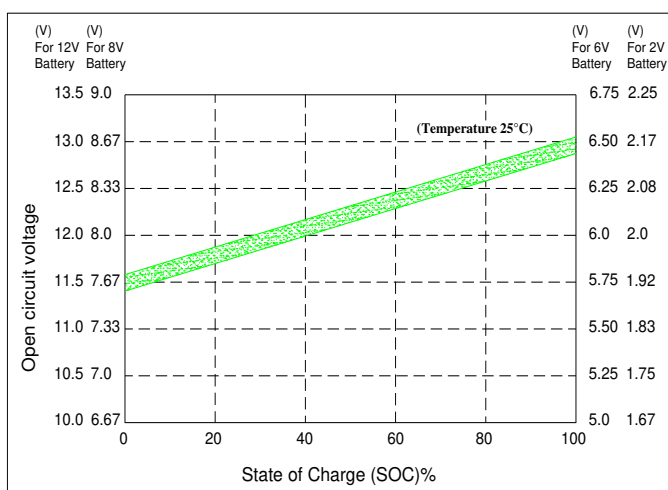

Capacity Retention Characteristic

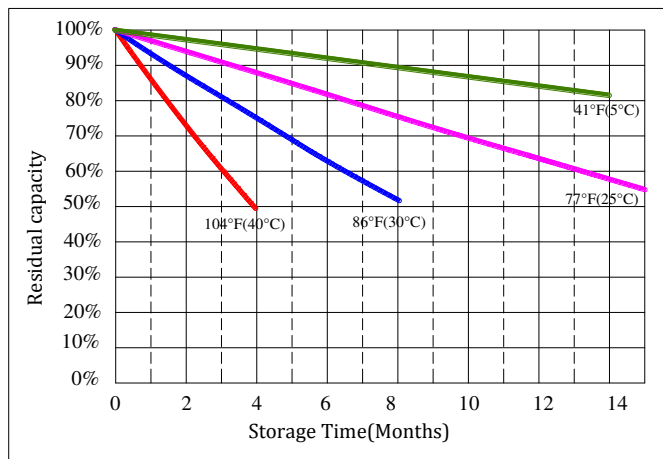

Cycle Life vs. Depth of Discharge(DOD)

