

MODEL **31-AGM**  
 VOLTAGE **12**  
 MATERIAL **Polypropylene**  
 DIMENSIONS **Inches (mm)**  
 BATTERY **VRLA AGM / Non-Spillable / Maintenance-Free**  
 COLOR **Maroon**  
 WATERING **No Watering Required** 



**12V**

**PRODUCT + PHYSICAL SPECIFICATIONS**

BCI Group Size	Type	Voltage	Terminal Type <sup>6</sup>	Dimensions <sup>c</sup> Inches (mm)			Weight Lbs. <sup>1</sup> (kg)
				Length	Width	Height <sup>f</sup>	
31	31-AGM	12	M8/DT				67 (30)
				12.80 (325)	6.81 (173)	9.37 (238)	

**ELECTRICAL SPECIFICATIONS**

Cranking Performance		Capacity <sup>A</sup> Minutes		Capacity <sup>B</sup> Amp-Hours (Ah)				Energy kWh	Internal Resistance (mΩ)	Short Circuit Current (A)
C.C.A. <sup>D</sup> @ 0°F (-18°C)	C.A. <sup>E</sup> @ 32°F (0°C)	@ 25 Amps	@ 75 Amps	5-Hr	10-Hr	20-Hr	100-Hr	100-Hr	4.80	2555
600	720	177	–	82	92	100	111	1.33		

**CHARGING INSTRUCTIONS**

Charger Voltage Settings (at 77°F/25°C)				
System Voltage	12V	24V	36V	48V
Maximum Charge Current (A)	20% of C <sub>20</sub>			
Absorption Voltage (2.40 V/cell)	14.40	28.80	43.20	57.60
Float Voltage (2.25 V/cell)	13.50	27.00	40.50	54.00

Do not install or charge batteries in a sealed or non-ventilated compartment. Constant under or overcharging will damage the battery and shorten its life as with any battery.

**CHARGING TEMPERATURE COMPENSATION**

Add	Subtract
0.005 volt per cell for every 1°C below 25°C 0.0028 volt per cell for every 1°F below 77°F	0.005 volt per cell for every 1°C above 25°C 0.0028 volt per cell for every 1°F above 77°F

**STATE OF CHARGE MEASURE OF OPEN-CIRCUIT VOLTAGE**

Percentage Charge	Cell	12 Volt
100	2.14	12.84
75	2.09	12.54
50	2.04	12.24
25	1.99	11.94
0	1.94	11.64

**OPERATIONAL DATA**

Operating Temperature	Self Discharge
-4°F to 122°F (-20°C to 50°C) At temperatures below 32°F (0°C) maintain a state of charge greater than 60%	Less than 3% per month depending on storage temperature conditions



Designed in compliance with applicable BCI, DIN, BS and IEC standards.  
 Tested in compliance to BCI and IEC standards.

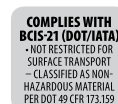

## TROJAN 31-AGM PERFORMANCE

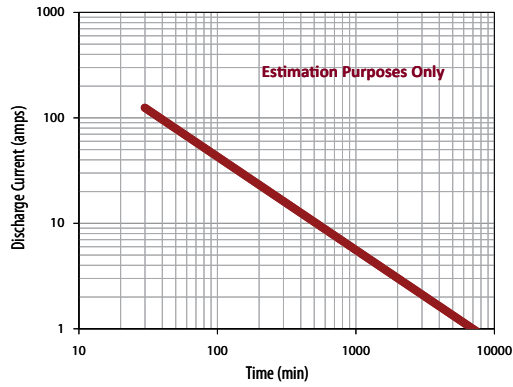

## PERCENT CAPACITY VS. TEMPERATURE

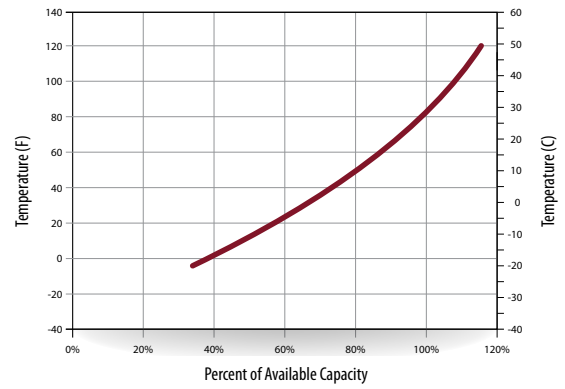

## SELF DISCHARGE VS. TIME<sup>H</sup>

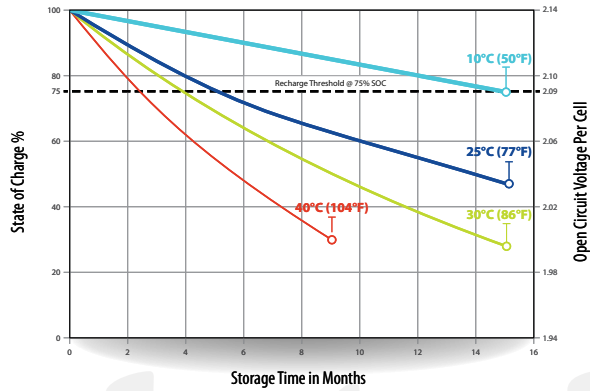

## BATTERY DIMENSIONS (shown with DT)

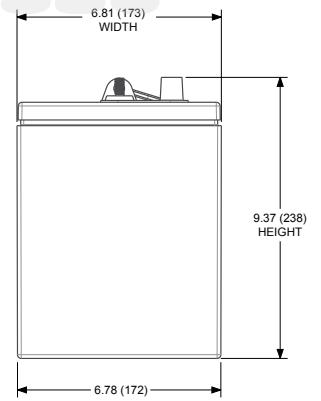
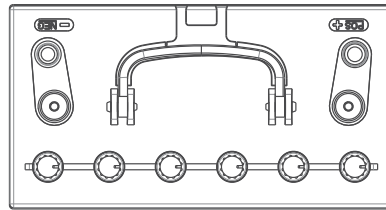
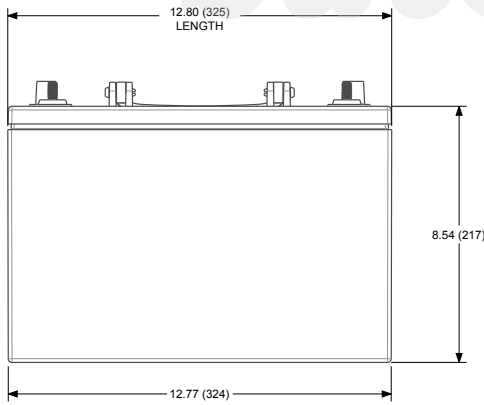

## TERMINAL CONFIGURATIONS<sup>G</sup>

M8



**Battery Height with Terminal in Inches (mm)**  
8.69 (221)

**Torque Values: in-lb (Nm)**  
Bolt: 85 - 90 (10 - 11)

DT

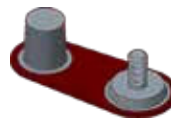

**Battery Height with Terminal in Inches (mm)**  
9.37 (238)

**Torque Values: in-lb (Nm)**  
Connected to Stud: 95 - 105 (11 - 12)  
Connected to AP: 50 - 70 (6 - 8)

**Bolt**  
5/16" - 18

- A. The number of minutes a battery can deliver when discharged at a constant rate at 80°F (27°C) and maintain a voltage above 1.75 V/cell. Capacities are based on peak performance.
- B. The amount of amp-hours (Ah) a battery can deliver when discharged at a constant rate at 80°F (27°C) for the 20-Hour rate and 86°F (30°C) for the 5-Hour rate and maintain a voltage above 1.75 V/cell. Capacities are based on peak performance.
- C. Dimensions may vary depending on type of handle or terminal. Batteries should be mounted with 0.5 inches (12.7 mm) spacing minimum.
- D. C.C.A. (Cold Cranking Amps) - the discharge load in amperes which a new, fully charged battery can maintain for 30 seconds at 0°F (-18°C) at a voltage above 1.2 V/cell.

- E. C.A. (Cranking Amps) - the discharge load in amperes which a new, fully charged battery can maintain for 30 seconds at 32°F (0°C) at a voltage above 1.2 V/cell. This is sometimes referred to as marine cranking amps @ 32°F or M.C.A. @ 32°F.
- F. Height taken from bottom of the battery to the highest point on the battery. Heights may vary depending on type of terminal.
- G. Terminal images are representative only.
- H. A boost charge should be performed every 6 months when batteries are in storage.
- I. Weight may vary.