

MODEL **SSIG 12 145**
 VOLTAGE **12**
 CAPACITY **145Ah @ 100Hr**
 MATERIAL **Polypropylene**
 BATTERY **Deep-Cycle Flooded/Advanced Lead Acid Battery**
 COLOR **Maroon**
 WATERING **No Watering System Available**



WITH T₂ TECHNOLOGY



12 VOLT

PHYSICAL SPECIFICATIONS

MODEL NAME	TERMINAL TYPE ^D	DIMENSIONS ^B INCHES (mm)			WEIGHT ^E LBS. (kg)	HYDROLINK OR SPWK	HANDLES
		LENGTH	WIDTH	HEIGHT ^C			
SSIG 12 145	9				66 (30)	N/A	Braided Rope
		13.94 (354)	6.75 (171)	10.09 (256)			

ELECTRICAL SPECIFICATIONS

VOLTAGE	CAPACITY ^A AMP-HOURS (Ah)					ENERGY (kWh)
	10-Hr	20-Hr	48-Hr	72-Hr	100-Hr	
12	122	132	135	140	145	1.74

CHARGING INSTRUCTIONS

CHARGER VOLTAGE SETTINGS (AT 77°F/25°C)			
SYSTEM VOLTAGE	12V	24V	48V
Maximum Charge Current (% of C ₂₀ Rate)*	13%		
Maximum Absorption Phase Time (hours)	4		
Absorption Voltage **	14.70	29.40	58.80
Float Voltage	13.50	27.00	54.00
Equalization Voltage	16.20	32.40	64.80

Do not install or charge batteries in a sealed or non-ventilated compartment. Constant under or overcharging will damage the battery and shorten its life as with any battery.
 *If charging time is limited contact Trojan Technical Support for assistance.
 **In cases where controller has a bulk voltage setting, use absorption voltage setting above.

RECYCLE RESPONSIBLY



CHARGING TEMPERATURE COMPENSATION

ADD	SUBTRACT
0.005 volt per cell for every 1°C below 25°C 0.0028 volt per cell for every 1°F below 77°F	0.005 volt per cell for every 1°C above 25°C 0.0028 volt per cell for every 1°F above 77°F

OPERATIONAL DATA

OPERATING TEMPERATURE	SELF DISCHARGE
-4°F to 113°F (-20°C to +45°C). At temperatures below 32°F (0°C) maintain a state of charge greater than 60%.	5 – 15% per month depending on storage temperature conditions.

STATE OF CHARGE MEASURE OF OPEN-CIRCUIT VOLTAGE

PERCENTAGE CHARGE	SPECIFIC GRAVITY	CELL	12 VOLT
100	1.277	2.122	12.73
90	1.258	2.103	12.62
80	1.238	2.083	12.50
70	1.217	2.062	12.37
60	1.195	2.040	12.24
50	1.172	2.017	12.10
40	1.148	1.993	11.96
30	1.124	1.969	11.81
20	1.098	1.943	11.66
10	1.073	1.918	11.51

DOD VS CYCLE LIFE IN A STATIONARY APPLICATION

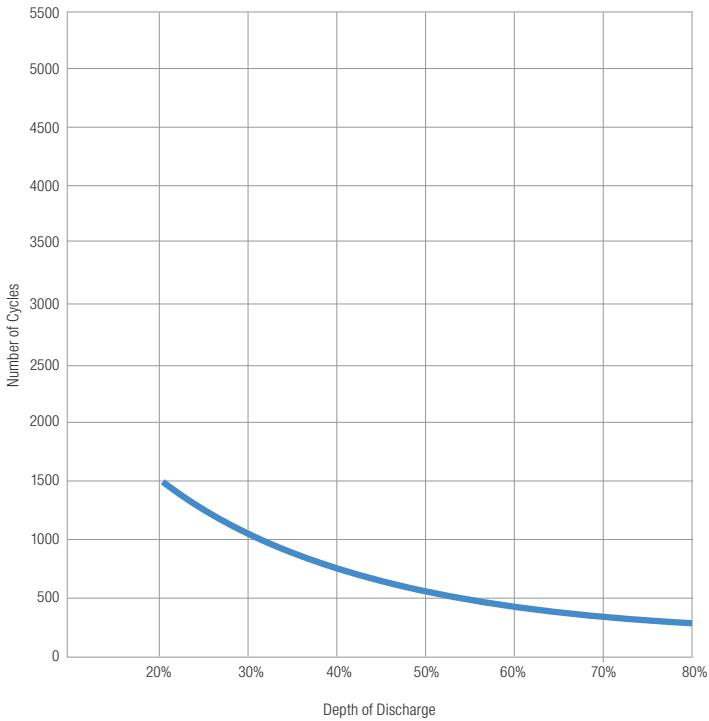

PERCENT CAPACITY VS. TEMPERATURE

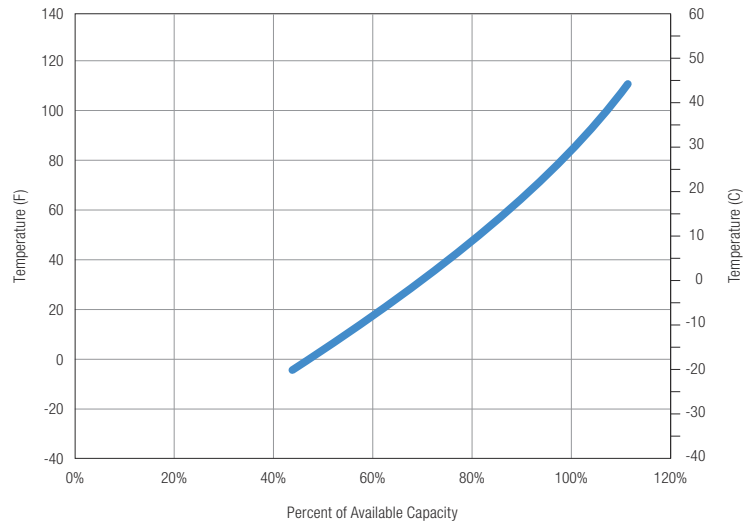

SELF DISCHARGE VS. TIME*

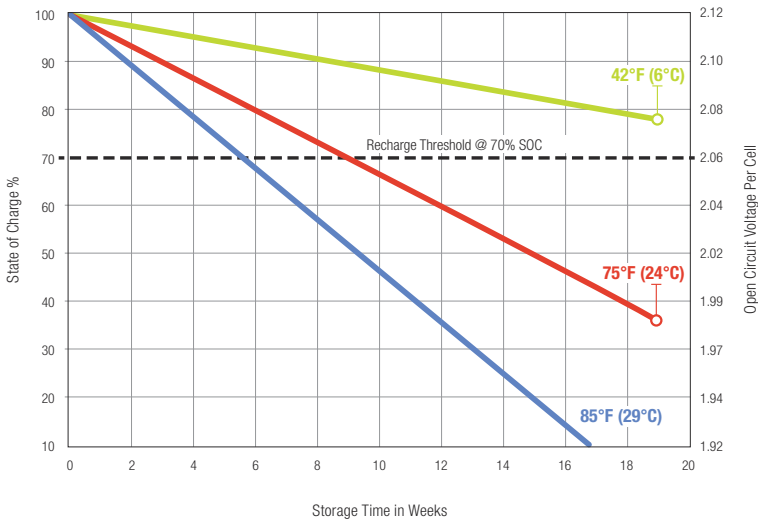

EXPECTED LIFE VS. TEMPERATURE

Chemical reactions internal to the battery are driven by voltage and temperature. The higher the battery temperature, the faster chemical reactions will occur. While higher temperatures can provide improved discharge performance the increased rate of chemical reactions will result in a corresponding loss of battery life. As a rule of thumb, for every 10°C increase in temperature the reaction rate doubles. Thus, a month of operation at 35°C is equivalent in battery life to two months at 25°C. Heat is an enemy of all lead acid batteries, FLA, AGM and gel alike and even small increases in temperature will have a major influence on battery life.

*PERIODIC CHARGE

FREQUENCY

Provide a periodic freshening charge to maintain a SOC greater than the threshold of 70%.

BATTERY DIMENSIONS (shown with WNT)

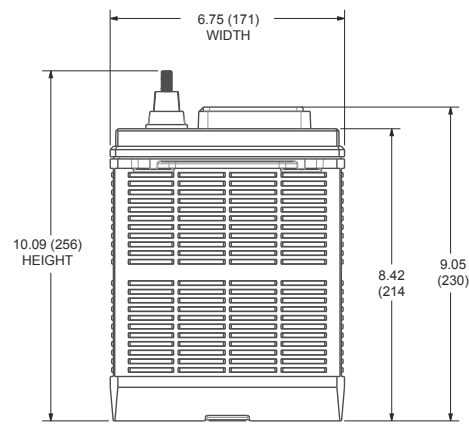
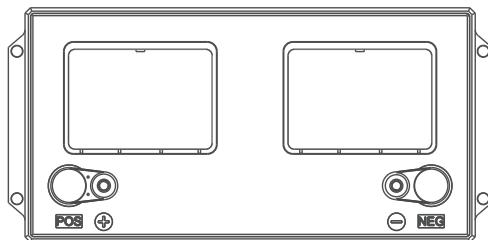
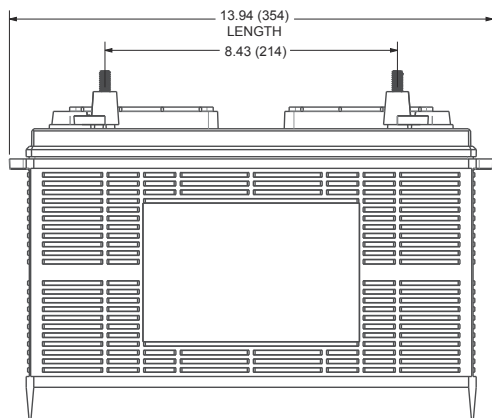

baterias.com

TERMINAL CONFIGURATIONS^D

9	WNT	WINGNUT TERMINAL
		<p>Terminal Height Inches (mm) 1.50 (38)</p> <p>Torque Values: in-lb (Nm) 95 – 105 (11 – 12)</p> <p>Bolt Size 5/16" – 18</p>

- A. The amount of amp-hours (Ah) a battery can deliver when discharged at a constant rate at 86°F (30°C) for all rates and maintain a voltage above 1.75 V/cell. Capacities are based on peak performance.
 B. Dimensions may vary depending on type of handle or terminal. Batteries should be mounted with 0.5 inches (12.7 mm) spacing minimum.

- C. Height taken from bottom of the battery to the highest point on the battery. Heights may vary depending on type of terminal.
 D. Terminal images are representative only.
 E. Weight may vary.



Designed in compliance with applicable BCI, DIN, BS and IEC standards.
 Tested in compliance to BCI and IEC standards.



800.423.6569 / +1.562.236.3000 / trojanbattery.com

SSIG 12 145_DS_030719

© 2019 Trojan Battery Company, LLC. All rights reserved. Trojan Battery Company is not liable for damages that may result from any information provided in or omitted from this publication, under any circumstances. Trojan Battery Company reserves the right to make adjustments to this publication at any time, without notice or obligation.